

Powerfoil®X3.0, our biggest, most powerful industrial fan, features a patented system of airfoils and winglets, setting the world standard for airflow. And now it comes standard with SmartSense technology.

IT'S BIG. IT'S BAD. IT MOVES A TON OF AIR.

- **SmartSense Technology** — Automatically adjusts fan speed based on user settings and a remote temperature sensor
- **Airfoils** — Eight patented Powerfoil airfoils (mill finish) with eight patent-pending AirFences
- **Winglets** — Powerfoil winglets eliminate wind noise (safety yellow)
- **Motor and Gearbox** — IP55 motor and NitroSeal™ Drive gearbox (STÖBER); fully sealed drive enclosure resists corrosion and reduces heat buildup for longer life
- **Onboard VFD** — Housed in an ABS/PVC-based enclosure with built-in heatsink; virtually eliminates RFI and EMI noise
- **Functional Platform** — Integrate lights, security cameras, speakers, or just about anything else you can imagine
- **Mounting Options** — Standard upper mount installs to I-beams and angle iron; optional kits allow for mounting to large I-beams, solid beams, Z-purlins, and pitched roofs
- **Safety Features** — Airfoil retainers, hub clips, safety cables, Grade 8 bolts, fire relay (must be wired during install if required by local code)
- **Color Customization** — Choose from one of our 11 classic colors, or dream up a color of your own

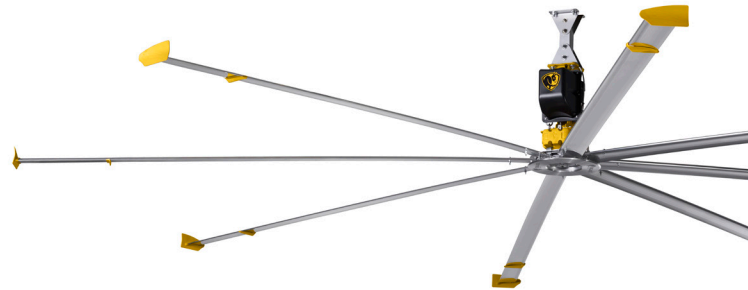

Onboard VFD and NitroSeal Drive Gearbox

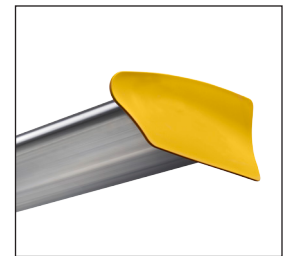

Powerfoil Winglet

Technical Specifications

Fan	Diameter (A)	Weight ¹	Max speed	Airfoil clearances ²	Input power and required breaker	Motor horsepower	Sound at max speed ³
PFX3-08	8 ft (2.4 m)	222 lb (101 kg)	197 RPM	2 ft (0.6 m) on sides 4 ft (1.2 m) below ceiling	200–240 VAC, 50/60 Hz, 1 Φ, 20 A 200–240 VAC, 50/60 Hz, 3 Φ, 10 A 400–480 VAC, 50/60 Hz, 3 Φ, 10 A	1.0 hp (0.75 kW)	< 55 dBA
PFX3-10	10 ft (3 m)	231 lb (105 kg)	160 RPM		200–240 VAC, 50/60 Hz, 1 Φ, 30 A 200–240 VAC, 50/60 Hz, 3 Φ, 20 A 400–480 VAC, 50/60 Hz, 3 Φ, 10 A		
PFX3-12	12 ft (3.6 m)	245 lb (111 kg)	139 RPM	2 ft (0.6 m) on sides	200–240 VAC, 50/60 Hz, 1 Φ, 30 A 200–240 VAC, 50/60 Hz, 3 Φ, 20 A	1.5 hp (1.1 kW)	
PFX3-14	14 ft (4.3 m)	254 lb (115 kg)	118 RPM	5 ft (1.5 m) below ceiling			
PFX3-16	16 ft (4.9 m)	264 lb (120 kg)	99 RPM	2 ft (0.6 m) on sides	400–480 VAC, 50/60 Hz, 3 Φ, 10 A 575–600 VAC, 50/60 Hz, 3 Φ, 10 A	2.0 hp (1.5 kW)	
PFX3-18	18 ft (5.5 m)	281 lb (127 kg)	88 RPM	6 ft (1.8 m) below ceiling			
PFX3-20	20 ft (6.1 m)	290 lb (132 kg)	78 RPM	2 ft (0.6 m) on sides			
PFX3-24	24 ft (7.3 m)	347 lb (157 kg)	65 RPM	7 ft (2.1 m) below ceiling			

¹ Weight does not include mount or extension tube.

² Measure the distance from the tip of the winglet to the ceiling or major obstruction.

³ Fans are sound tested at maximum speed in a laboratory environment. Actual results in field conditions may vary due to sound reflecting surfaces and environmental conditions.

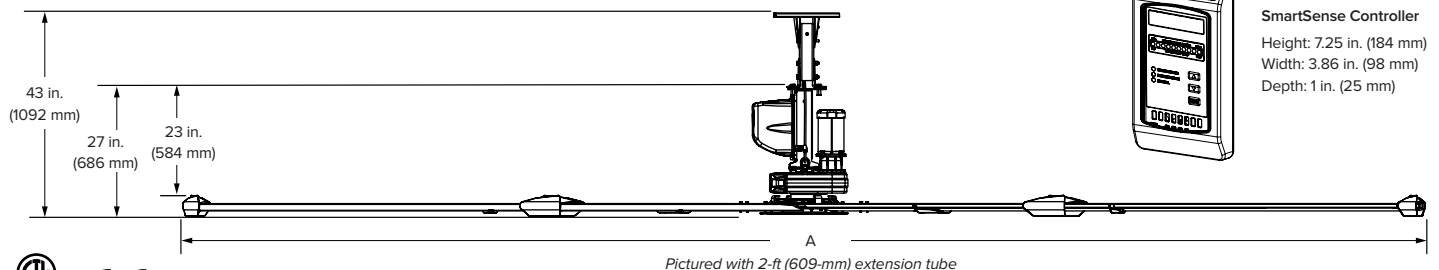

SmartSense Controller
Height: 7.25 in. (184 mm)
Width: 3.86 in. (98 mm)
Depth: 1 in. (25 mm)



Certified to UL 507 and CSA C22.2

Lead times may vary. See full warranty for coverage information. Specifications subject to change without notice.



AMERICAS
BIGASSOLUTIONS.COM
877-244-3267

CANADA
BIGASSOLUTIONS.COM/CA
844-924-4277

AUSTRALIA
BIGASSOLUTIONS.COM/AU
1-300-244-277

HONG KONG
BIGASSOLUTIONS.COM/HK
+852 2836 5808

SINGAPORE
BIGASSOLUTIONS.COM/SG
+65 6709 8500

MALAYSIA
+603 5565 0888

Powerfoil X3.0 Plus

TECHNICAL SPECIFICATIONS

Powerfoil[®] X3.0 Plus, our biggest, most powerful industrial fan, features a patented system of airfoils and winglets, setting the world standard for airflow. And now it comes with a brain, also known as SmartSense technology.

IT'S BIG. IT'S BAD. IT MOVES A TON OF AIR.

- **SmartSense Technology** — Automatically adjusts fan speed based on user settings and a remote temperature sensor
- **Airfoils** — Eight patented Powerfoil airfoils (mill finish) with eight patent-pending AirFences
- **Winglets** — Powerfoil Plus winglets push air at an angle, moving it over and around obstructions (safety yellow)
- **Motor and Gearbox** — IP55 motor and NitroSeal[™] Drive gearbox (STÖBER[®]); fully sealed drive enclosure resists corrosion and reduces heat buildup for longer life
- **Onboard VFD** — Housed in an ABS/PVC-based enclosure with built-in heatsink; virtually eliminates RFI and EMI noise
- **Functional Platform** — Integrate lights, security cameras, speakers, or just about anything else you can imagine
- **Mounting Options** — Standard upper mount installs to I-beams and angle iron; optional kits allow for mounting to large I-beams, solid beams, Z-purlins, and pitched roofs
- **Safety Features** — Airfoil retainers, hub clips, safety cables, Grade 8 bolts, fire relay (must be wired during install if required by local code)
- **Color Customization** — Choose from one of our 11 classic colors, or dream up a color of your own

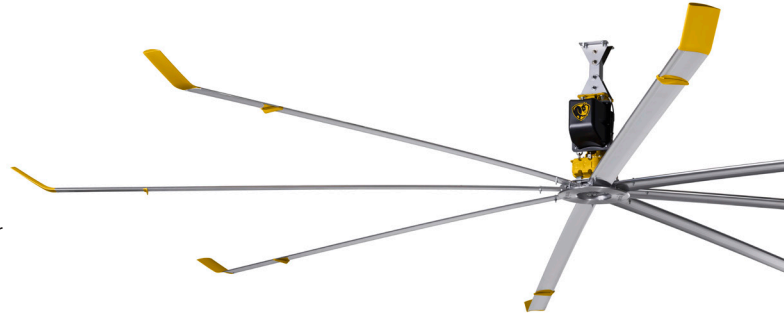

Onboard VFD and NitroSeal Drive Gearbox

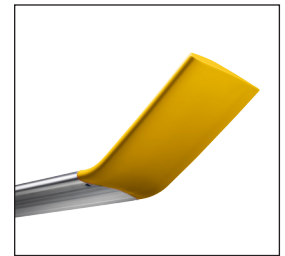

Powerfoil Plus Winglet

Technical Specifications

Fan	Diameter (A)	Weight ¹	Max speed	Airfoil clearances ²	Motor horsepower	Input power and required breaker	Sound at max speed ³
PPX3-10	12 ft (3.7 m)	240 lb (109 kg)	140 RPM	2 ft (0.6 m) on sides 5 ft (1.5 m) below ceiling	1.5 hp (1.1 kW)	200–240 VAC, 50/60 Hz, 1 Φ, 30 A 200–240 VAC, 50/60 Hz, 3 Φ, 20 A 400–480 VAC, 50/60 Hz, 3 Φ, 10 A 575–600 VAC, 50/60 Hz, 3 Φ, 10 A	< 55 dBA
PPX3-12	14 ft (4.3 m)	249 lb (113 kg)	118 RPM	2 ft (0.6 m) on sides			
PPX3-14	16 ft (4.9 m)	259 lb (117 kg)	99 RPM	6 ft (1.8 m) below ceiling			
PPX3-16	18 ft (5.5 m)	276 lb (125 kg)	89 RPM	2 ft (0.6 m) on sides			
PPX3-18	20 ft (6.1 m)	285 lb (129 kg)	78 RPM	7 ft (2.1 m) below ceiling			
PPX3-20	22 ft (6.7 m)	334 lb (152 kg)	70 RPM	2 ft (0.6 m) on sides			
PPX3-24	24 ft (7.3 m)	343 lb (156 kg)	62 RPM	8 ft (2.4 m) below ceiling	2.0 hp (1.5 kW)		

¹ Weight does not include mount or extension tube.

² Measure the distance from the tip of the winglet to the ceiling or major obstruction.

³ Fans are sound tested at maximum speed in a laboratory environment. Actual results in field conditions may vary due to sound reflecting surfaces and environmental conditions.

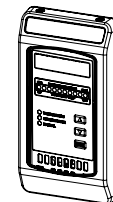
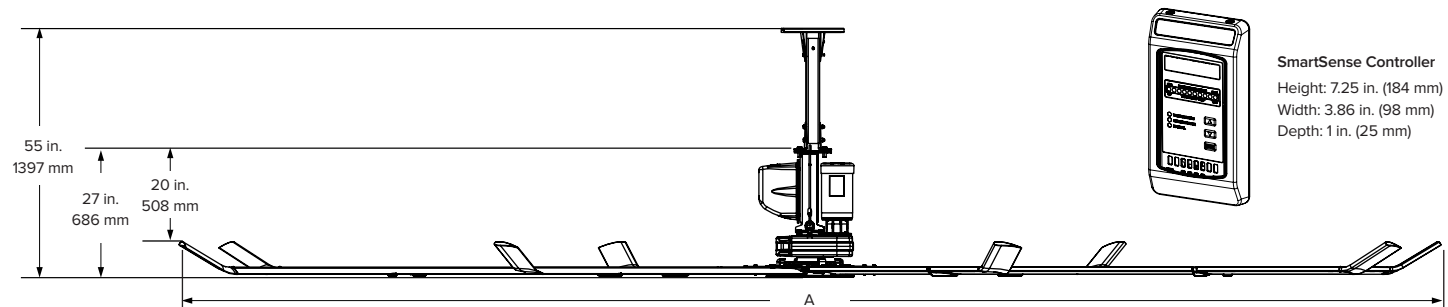

SmartSense Controller
Height: 7.25 in. (184 mm)
Width: 3.86 in. (98 mm)
Depth: 1 in. (25 mm)



Certified to UL 507 and CSA C22.2

Lead times may vary. See full warranty for coverage information. Specifications subject to change without notice.



AMERICAS
BIGASSOLUTIONS.COM
877-244-3267

CANADA
BIGASSOLUTIONS.COM/CA
844-924-4277

AUSTRALIA
BIGASSOLUTIONS.COM/AU
1-300-244-277

HONG KONG
BIGASSOLUTIONS.COM/HK
+852 2836 5808

SINGAPORE
BIGASSOLUTIONS.COM/SG
+65 6709 8500

MALAYSIA
+603 5565 0888